

Group R-70 to R-75: only Vauxhall

Subject

Sound Package

Vehicles

Omega-B (only Saloon)

General

The Sound Package is available exclusively together with Radios SC 804 CDC or CD 300 RDS. In addition to the standard equipment (8 loudspeakers), the Sound Package offers a sound processor and two bass loudspeakers.

The sound processor is optimally tuned to the acoustics of the Omega-B Saloon. It consists of an amplifier and an equaliser which is pre-set and cannot be altered.

Location of Components in Vehicle

- 1 Treble speaker, front door, left
- 2 Radio
- 3 Treble speaker, front door, right
- 4 Wiring harness plug X7, instrument panel & radio, rear
- 5 Wide band loudspeaker, front door, right
- 6 Treble speaker, rear door, right
- 7 Wide band loudspeaker, rear door, right
- 8 Bass loudspeaker, rear, right
- 9 CD changer
- 10 Bass loudspeaker, rear, left
- 11 Sound processor
- 12 Wide band loudspeaker, rear door, left
- 13 Treble speaker, rear door, left
- 14 Wide band loudspeaker, front door, left
- 15 Wiring harness plug X1, instrument panel & body

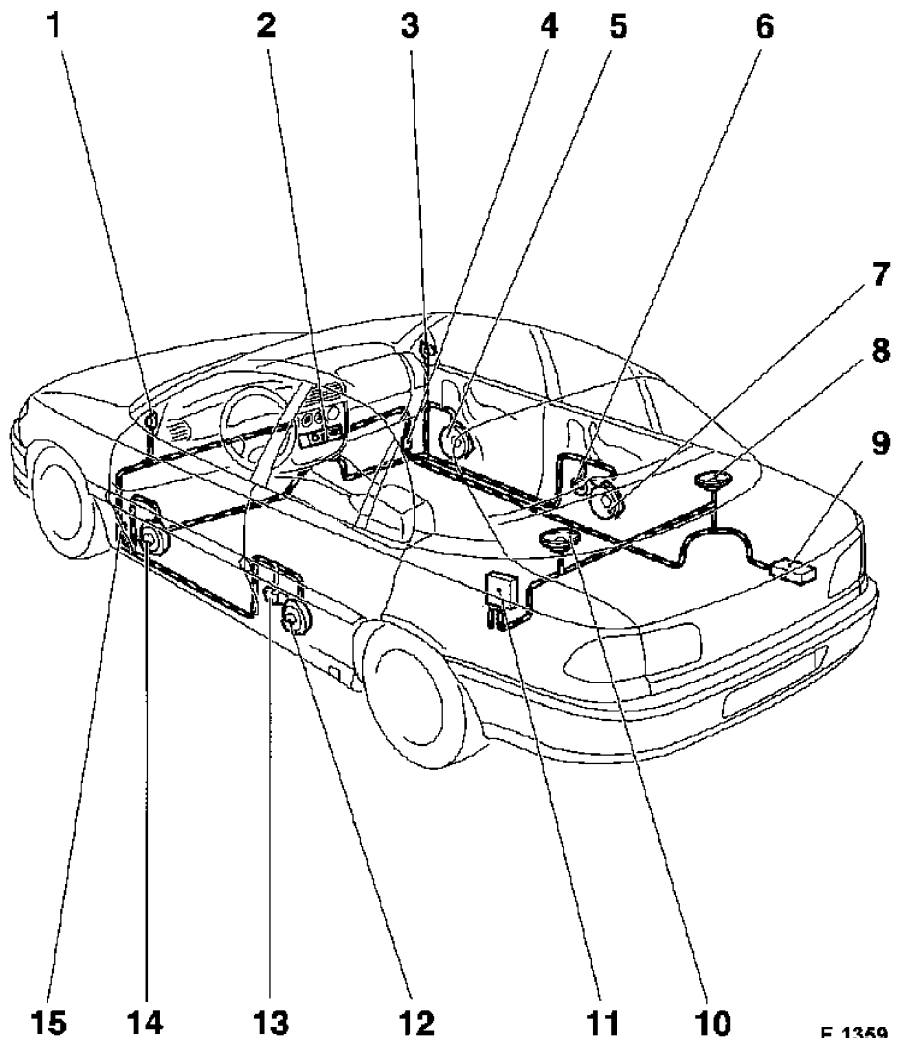

F 1359



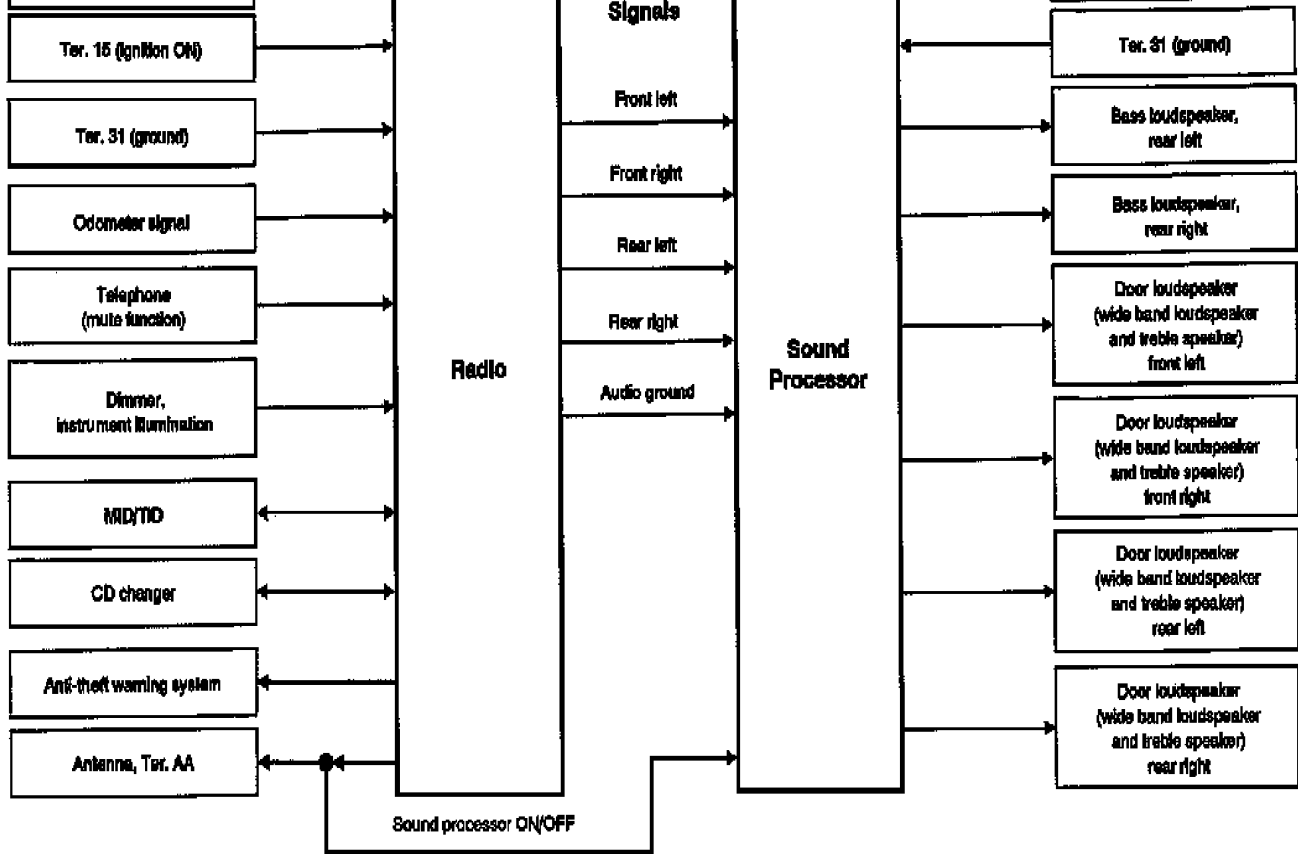

Circuit Diagram

(Excerpt from Overall Circuit Diagram)

Unit Identification	Current Path
E19 Heated rear screen, antenna	1060
F4 Fuse, CD changer	1077
F6 Fuse, sound processor	1034
F12 Fuse, instrument illumination	-
H1 Radio	1045
H37 Wide band loudspeaker, front door, left	1039
H38 Wide band loudspeaker, front door, right	1044
H39 Wide band loudspeaker, rear door, left	1048
H40 Wide band loudspeaker, rear door, right	1052
H52 Treble speaker, front door, left	1039
H53 Treble speaker, front door, right	1044
H57 Treble speaker, rear door, left	1048
H58 Treble speaker, rear door, right	1052
H61 Bass loudspeaker, rear, left	1037
H62 Bass loudspeaker, rear, right	1040
U18 Amplifier, antenna, rear screen	1060
U23 Sound processor	1034
U24 CD changer	1070
X1 Instrument panel & body	1039
X7 Instrument panel & radio, rear	1034
X11 Body & driver's door	1039, 1044
X12 Body & co-driver's door	1039, 1044
X13 Body & rear door, left	1048
X14 Body & rear door, right	1052

Abbreviations

- BEL Instrument illumination
- CD CD changer
- DWA Anti-theft warning system
- EMP Radio
- HS Heated rear screen
- ID Info-Display (TID/MID)
- KW Estate
- TEL Telephone
- WEG Odometer signal

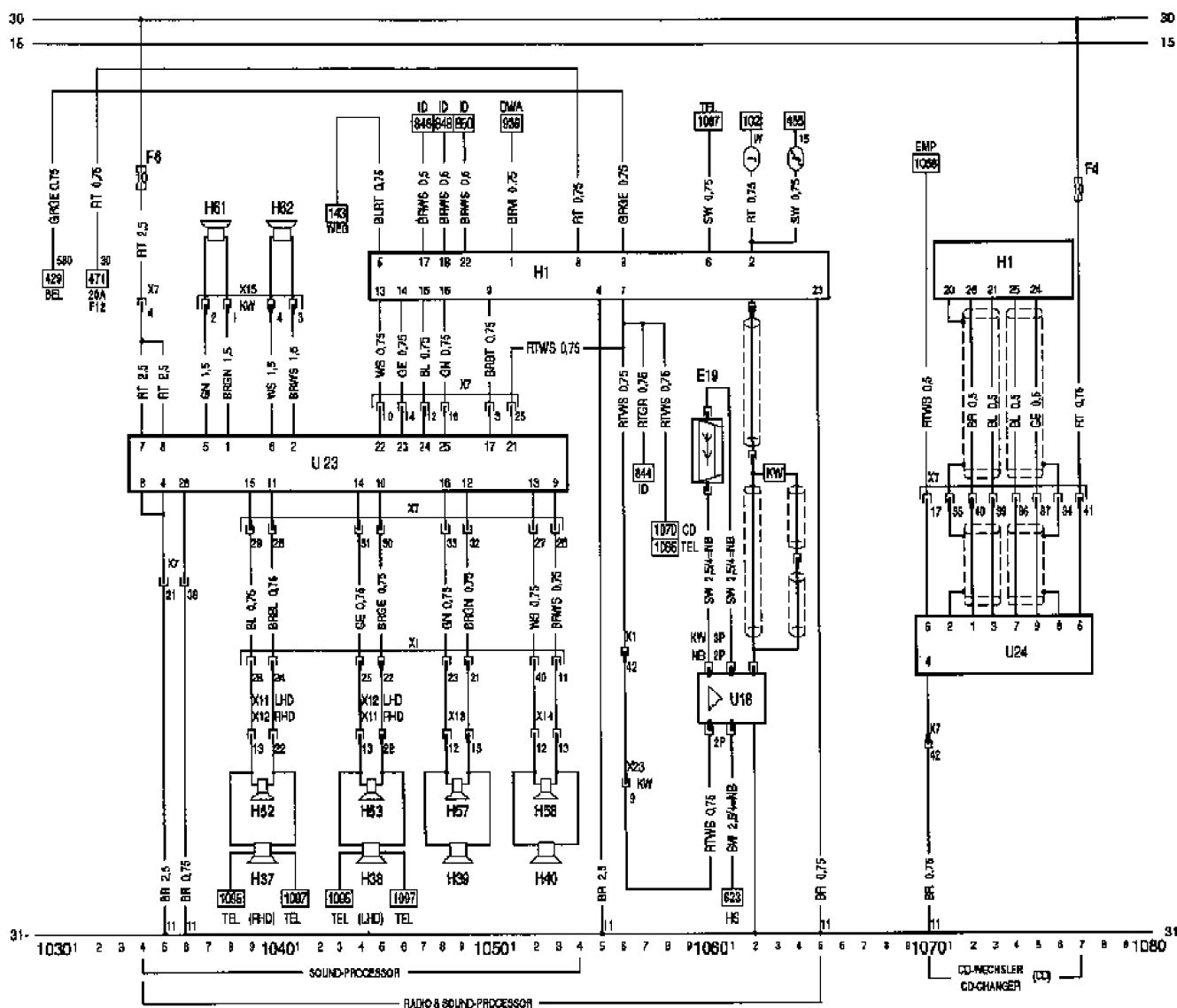

F 1360

Terminal Assignment

Sound Processor, 26-pin

- 1 Output (-), bass loudspeaker, rear, left
- 2 Output (-), bass loudspeaker, rear, right

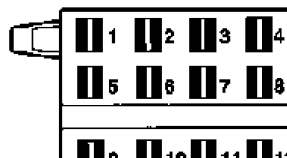

- 4 Ground (Ter. 31)
- 5 Output (+) bass loudspeaker, rear, left
- 6 Output (+) bass loudspeaker, rear, right
- 7 Battery + (Ter. 30) from fuse F6
- 8 Battery + (Ter. 30) from fuse F6
- 9 Output (-), door loudspeaker, rear, right
- 10 Output (-), door loudspeaker, front, right
- 11 Output (-), door loudspeaker, front, left
- 12 Output (-), door loudspeaker, rear, left
- 13 Output (+), door loudspeaker, rear, right
- 14 Output (+), door loudspeaker, front, right
- 15 Output (+), door loudspeaker, front, left
- 16 Output (+), door loudspeaker, rear, left
- 17 Input, audio ground from radio (pin 9)
- 18 Not occupied
- 19 Not occupied
- 20 Not occupied
- 21 Input, sound processor ON/OFF from radio (pin 7)
- 22 Input, audio signal, rear right, from radio (pin 13)
- 23 Input, audio signal, front right, from radio (pin 14)
- 24 Input, audio signal, front left, from radio (pin 15)
- 25 Input, audio signal, rear left, from radio (pin 16)
- 26 Ground (Ter. 31)

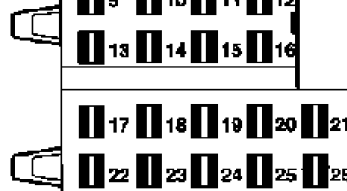

F 1361

Radios SC 804 CDC/CD 300 RDS, 26-pin

- 1 Ground, signal output to anti-theft warning system
- 2 Ignition ON (Ter. 15)
- 3 Voltage supply for illumination from dimmer, instrument illumination (Ter. 58d)
- 4 Ground (Ter. 31)
- 5 Input, odometer signal
- 6 Input, radio mute function from telephone
- 7 ON/OFF circuit output for sound processor (pin 21), CD changer (pin 6), antenna amplifier, MID/TID, telephone
- 8 Battery + (Ter. 30) from fuse F12
- 9 Output, audio ground to sound processor (pin 17)
- 10 Not occupied
- 11 Not occupied
- 12 Not occupied
- 13 Output, audio signal, rear right, to sound processor (pin 22)
- 14 Output, audio signal, front right, to sound processor (pin 23)
- 15 Output, audio signal, front left, to sound processor (pin 24)
- 16 Output, audio signal, rear left, to sound processor (pin 25)
- 17 Data lead SCL to MID/TID
- 18 Data lead MRQ to MID/TID
- 19 Not occupied

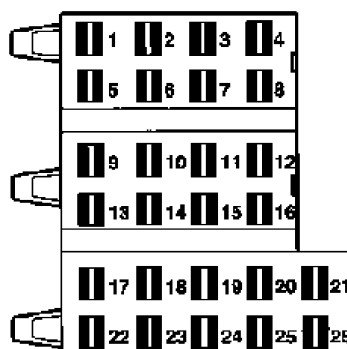

F 1361

- 20 Input, audio ground from CD changer (pin 2)
- 21 Input, audio signal, right, from CD changer (pin 3)
- 22 Data lead SDA to MID/TID
- 23 Ground (Ter. 31)
- 24 Data lead + D² B to CD changer (pin 9)
- 25 Data lead - D² B to CD changer (pin 7)
- 26 Input, audio signal, left, from CD changer (pin 1)

CD Changer, 9-pin

- 1 Output, audio signal, left, to radio (pin 26)
- 2 Output, audio ground to radio (pin 20)
- 3 Output, audio signal, right, to radio (pin 21)
- 4 Ground (Ter. 31)
- 5 Battery + (Ter. 30) from fuse F4
- 6 Input, CD changer ON/OFF from radio (pin 7)
- 7 - D² B data lead from radio (pin 25)
- 8 Ground, data lead from radio
- 9 + D² B data lead from radio (pin 24)

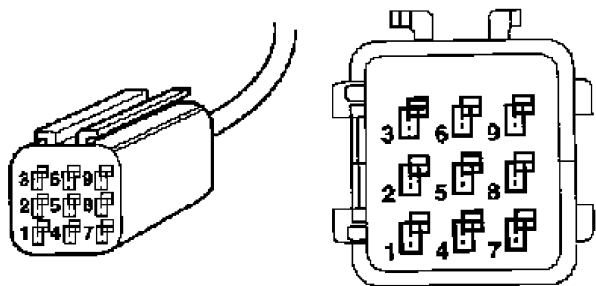

F 1362

42-pin Wiring Harness Plug, Instrument Panel & Radio, Rear, X7 (footwell, front right)

- 3 Audio ground from radio to sound processor
- 4 Battery + (Ter. 30) for sound processor from fuse F6
- 8 Radio mute function from telephone
- 10 Audio signal, rear right, from radio to sound processor
- 12 Audio signal, front left, from radio to sound processor
- 14 Audio signal, front right, from radio to sound processor
- 16 Audio signal, rear left, from radio to sound processor
- 17 Control lead from radio to CD changer ON/OFF
- 18 Control lead from radio to telephone ON/OFF
- 21 Ground (Ter. 31) for sound processor
- 25 Control lead from radio to sound processor ON/OFF
- 26 Audio (-) from sound processor to loudspeaker, rear door, right
- 27 Audio (+) from sound processor to loudspeaker, rear door, right
- 28 Audio (-) from sound processor to loudspeaker, front door, left
- 29 Audio (+) from sound processor to loudspeaker, front door, left
- 30 Audio (-) from sound processor to loudspeaker, front door, right

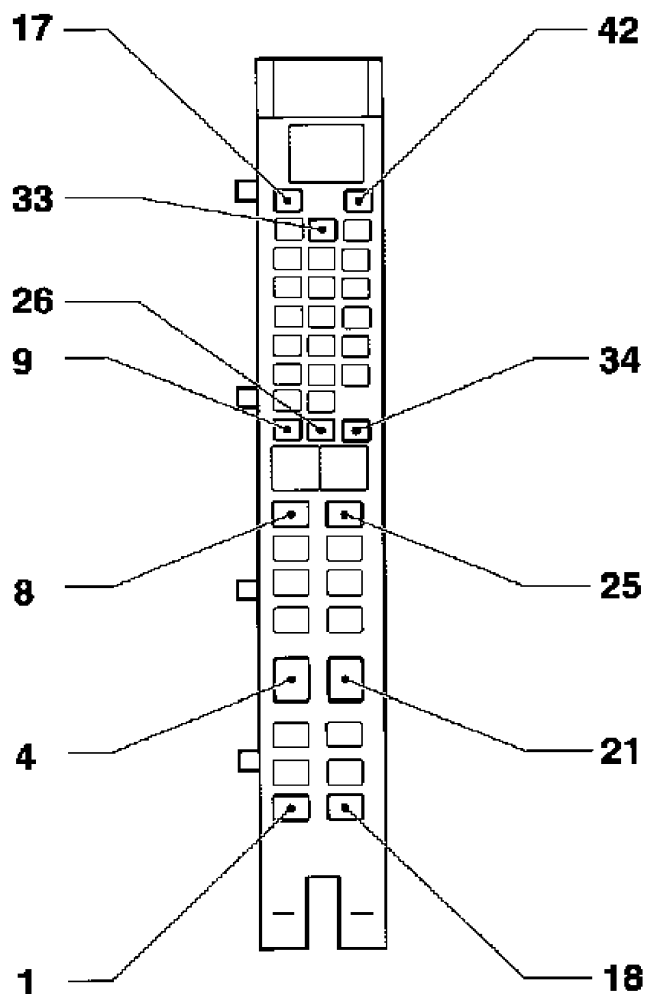

F 1363

- 31 Audio (+) from sound processor to loudspeaker, front door, right
- 32 Audio (-) from sound processor to loudspeaker, rear door, left
- 33 Audio (+) from sound processor to loudspeaker, rear door, left
- 34 Ground, data lead from radio to CD changer
- 35 Audio ground from CD changer to radio
- 36 - D²B data lead from radio to CD changer
- 37 + D²B data lead from radio to CD changer
- 38 Ground (Ter. 31) for sound processor
- 39 Audio signal, right, from CD changer to radio
- 40 Audio signal, left, from CD changer to radio
- 41 Battery + (Ter. 30) for CD changer from fuse F4
- 42 Ground (Ter. 31) for CD changer

Technical Data

Sound processor - pre-set equaliser with integrated amplifier

Frequency range:	20-20,000 Hz
Power:	4 x 20 watt (door loudspeakers) 2 x 40 watt (bass speakers)
Total harmonic distortion:	below 0.1 %
Signal noise interval:	above 80 dB
Channel voice-over damping:	above 40 dB
Weight:	approx. 1.5 kg
Dimensions:	200 x 55 x 165 (mm)

Sound Processor, Remove and Install

- Open luggage compartment lid.
- Remove spare wheel cover.
- Detach spare wheel and remove.
- Push wiring harness bracket (1) to the left.
- Pull inner rear left quarter panel forwards (arrow).
- Loosen fastening bolts (2), do not unscrew.
- Push sound processor approx. 10 mm backwards, then to the left (guide bolt heads through fastening holes) into space between inner and outer rear left quarter panel.
- Remove sound processor backwards.

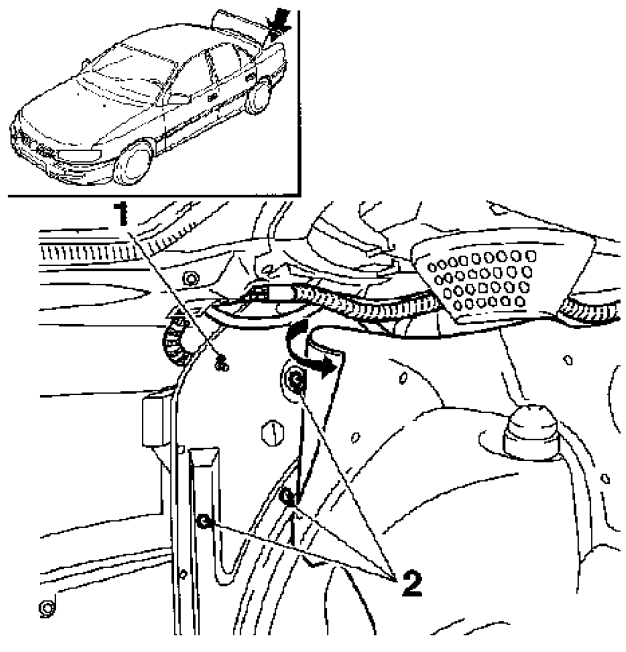

Release and remove wiring harness plug as shown in illustration F 1364 (below).

Install analogously in reversed order.

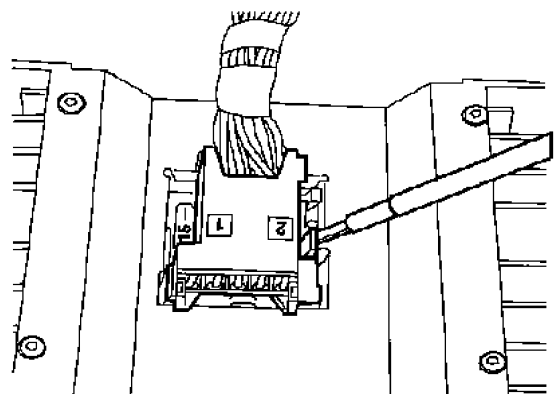

Checking Procedures

In the event of customer complaints, subject voltage supply and loudspeakers including wiring to a quick check according to the checking procedures before replacing the sound processor.

Before performing the check, remove sound processor as described and check that the wiring harness plug is correctly connected and that the catch is properly engaged.

If the fault is not eliminated by this, find the required test steps from the fault description in the trouble-shooting chart.

Trouble-shooting Chart

Before trouble-shooting, switch off radio, release and remove sound processor wiring harness plug. Inspect plug contacts of wiring harness plug.

Designation	Test Step								
	1	2	3	4	5	6	7	8	9
No function of sound processor	•	•	•						
No function of one or both bass loudspeakers				•	•				
No function of loudspeaker in driver's door						•			
No function of loudspeaker in co-driver's door							•		
No function of loudspeaker in left rear door								•	
No function of loudspeaker in right rear door									•

Test Step	Tester Multimeter MKM-587-A	Test			Notes	Nominal Value
		from	between			
1	Ohmmeter, range 200 Ω	Fuse in sound processor	Ter. 1	Ter. 2	<ul style="list-style-type: none"> Remove fuse beside sound processor plug. Measurement between both contacts of fuse. 	approx. 0 Ω
<p>Possible faults: (If nominal value is not attained)</p> <p>Fuse in sound processor defective.</p>						
2	Voltmeter, range 20 V, DC	Voltage supply to sound processor	Ter. 3	Ter. 7	<ul style="list-style-type: none"> Measurements in sound processor wiring harness plug 	higher than 11,5 V
			Ter. 3	Ter. 8		higher than 11,5 V
			Ter. 4	Ter. 7		higher than 11,5 V
			Ter. 4	Ter. 8		higher than

Possible faults:

(If nominal value is not attained)

Fuse F6 defective.

Interruption in instrument panel wiring harness between fuse F6 and wiring harness plug X7/Ter. 4.

Interruption in instrument panel wiring harness between grounding point 11 (on steering bracket) and wiring harness plug X7/Ter. 21.

Grounding point 11 corroded.

Interruption in radio wiring harness, rear, between wiring harness plug X7 and sound processor wiring harness plug.

Wiring harness plug X7 (instrument panel & radio, rear) disconnected.

3	Ohmmeter, range 200 Ω	Bridges in sound processor wiring harness plug	Ter. 7 Ter. 3	Ter. 8 Ter. 4	<ul style="list-style-type: none"> Measurements in sound processor wiring harness plug 	approx. 0 Ω approx. 0 Ω
Possible faults: (If nominal value is not attained) Bridge in sound processor wiring harness plug between Ter. 3 and Ter. 4 interrupted. Bridge in sound processor wiring harness plug between Ter. 7 and Ter. 8 interrupted.						
4	Ohmmeter, range 200 Ω	Bass loudspeaker, rear, left, loudspeaker lead	Ter. 1	Ter. 5	<ul style="list-style-type: none"> Measurements in sound processor wiring harness plug 	6,5 - 7,5 Ω
Possible faults: (If nominal value is not attained) Interruption in radio wiring harness, rear, between sound processor wiring harness plug and bass loudspeaker, rear left. Wiring harness plug at bass loudspeaker, rear left, disconnected. Bass loudspeaker, rear left, defective.						
5	Ohmmeter, range 200 Ω	Bass loudspeaker, rear right, loudspeaker lead	Ter. 2	Ter. 6	<ul style="list-style-type: none"> Measurements in sound processor wiring harness plug 	6,5 - 7,5 Ω
Possible faults: (If nominal value is not attained) Interruption in radio wiring harness, rear, between sound processor wiring harness plug and bass loudspeaker, rear right. Wiring harness plug at bass loudspeaker, rear right, disconnected. Bass loudspeaker, rear right, defective.						
6	Ohmmeter, range 200 Ω	Door loudspeakers	Ter. 11	Ter. 15	<ul style="list-style-type: none"> Measurements in sound processor wiring harness 	3 - 4 Ω

	(front door, left)			plug	
<p>Possible faults: (If nominal value is not attained)</p> <p>Interruption in radio wiring harness, rear, between sound processor wiring harness plug and wiring harness plug X7. Wiring harness plug X7 (instrument panel & radio, rear) disconnected. Interruption in instrument panel between wiring harness plug X7 and wiring harness plug X1. Wiring harness plug X1 (instrument panel & body) disconnected. Interruption in body wiring harness between wiring harness plug X1 and wiring harness plug X11* (front door, left). Wiring harness plug X11* (front door, left) disconnected. Interruption in front door wiring harness, left, between wiring harness plug X11* and loudspeaker, front door, left. Wiring harness plug at loudspeaker, front door, left, disconnected. Loudspeaker, front door, left, defective.</p> <p>*) X12 on RHD</p>					

7	Ohmmeter, range 200 Ω	Door loudspeakers and their leads (front door, right)	Ter. 10	Ter. 14	<ul style="list-style-type: none"> Measurements in sound processor wiring harness plug 	3 - 4 Ω
<p>Possible faults: (If nominal value is not attained)</p> <p>Interruption in radio wiring harness, rear, between sound processor wiring harness plug and wiring harness plug X7. Wiring harness plug X7 (instrument panel & radio, rear) disconnected. Interruption in instrument panel wiring harness between wiring harness plug X7 and wiring harness plug X1. Wiring harness plug X1 (instrument panel & body) disconnected. Interruption in body wiring harness between wiring harness plug X1 and wiring harness plug X12* (front door, right). Wiring harness plug X12* (front door, right) disconnected. Interruption in front door wiring harness, right, between wiring harness plug X12* and loudspeaker, front door, right. Wiring harness plug at loudspeaker, front door, right, disconnected. Loudspeaker, front door, right, defective.</p> <p>*) X11 on RHD</p>						

8	Ohmmeter, range 200 Ω	Door loudspeakers and their leads (rear door, left)	Ter. 12	Ter. 16	<ul style="list-style-type: none"> Measurements in sound processor wiring harness plug 	3,5 - 4,5 Ω
---	------------------------------	---	---------	---------	---	--------------------

Possible faults:
(If nominal value is not attained)

	<p>Interruption in radio wiring harness, rear, between sound processor wiring harness plug and wiring harness plug X7. Wiring harness plug X7 (instrument panel & radio, rear) disconnected. Interruption in instrument panel wiring harness between wiring harness plug X7 und wiring harness plug X1. Wiring harness plug X1 (instrument panel & body) disconnected. Interruption in body wiring harness between wiring harness plug X1 and wiring harness plug X13 (rear door, left). Wiring harness plug X13 (rear door, left) disconnected. Interruption in rear door wiring harness, left, between wiring harness plug X13 and loudspeaker, rear door, left. Wiring harness plug at loudspeaker, rear door, left, disconnected. Loudspeaker, rear door, left, defective.</p>					
9	Ohmmeter, range 200 Ω	Door loudspeakers and their leads (rear door, right)	Ter. 9	Ter. 13	• Measurements in sound processor wiring harness plug	3,5 - 4,5 Ω
<p>Possible faults: (If nominal value is not attained)</p> <p>Interruption in radio wiring harness, rear, between sound processor wiring harness plug and wiring harness plug X7. Wiring harness plug X7 (instrument panel & radio, rear) disconnected. Interruption in instrument panel wiring harness between wiring harness plug X7 und wiring harness plug X1. Wiring harness plug X1 (instrument panel & body) disconnected. Interruption in body wiring harness between wiring harness plug X1 and wiring harness plug X14 (rear door, right). Wiring harness plug X14 (rear door, right) disconnected. Interruption in rear door wiring harness, right, between wiring harness plug X14 and loudspeaker, rear door, right. Wiring harness plug at loudspeaker, rear door, right, disconnected. Loudspeaker, rear door, right, defective.</p>						

Time Allowance

R 2024 10	<u>Sound Processor (Radio Amplifier) - Replace</u> TC: 27, 29, 54, 86, 87	.2 hrs
01	Add: Check sound processor	.2 hrs
	<u>Loudspeakers, Rear - Replace</u> TC: 27, 29, 86, 87 +: R + R hat shelf	
R 2130 00	Both bass loudspeakers	.6 hrs
R 2131 00	Right bass loudspeaker	.5 hrs
R 2132 00	Left bass loudspeaker	.5 hrs

	Add:	
03	R + R electric sunscreen for rear screen	.2 hrs
W 1000 00	<u>Vehicle from Parking Place to Workshop and Back</u> TC: 99	.2 hrs